

HATL01F

Automatic fan control module for Raspberry Pi.

Do you want to the life of your fan, reduce its noise and control it automatically? With this automatic fan MaticControl module you will be able to do this. Place it on pins 1-8. And this is all you have to do on the hardware.

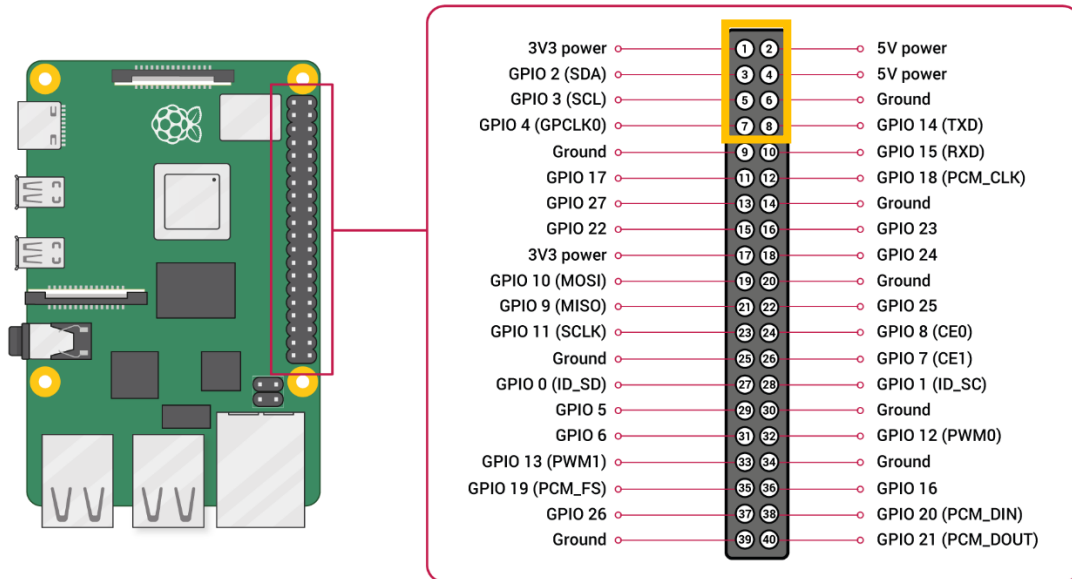

About the software you have two options:

1. Graphical

From Raspberry icon > Preferences> Raspberry Pi Configuration > Performance tab >set fan enable; Fan GPIO 4; and the temperature at which you want the fan to turn on. Save with OK

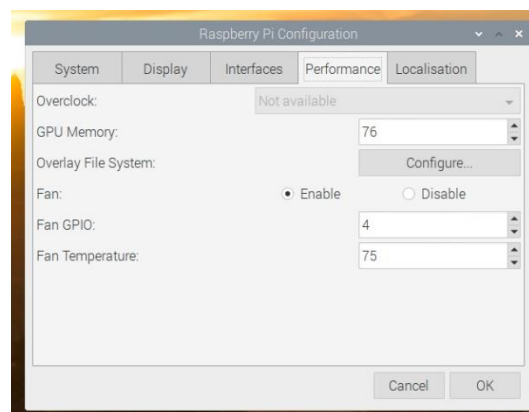
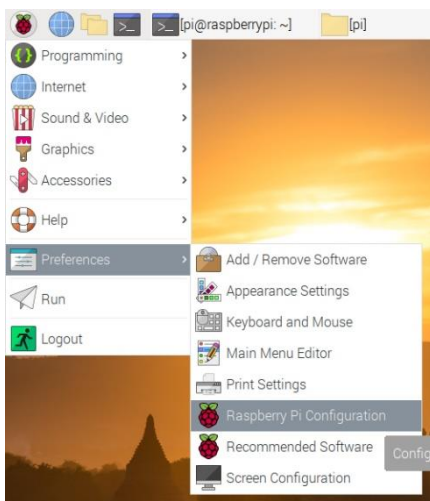

Thus, when the processor reaches the temperature you set, the fan will turn on. It will turn on off only when the processor temperature drops 10 degrees below the set on temperature. (For example, if you set the On temperature to 75 degrees, the fan will turn off when the processor reaches 65 degrees).

With these few easy steps, you now have automatic fan control.

2. Console

Open the Console and type
`sudo raspi-config`

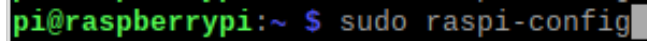

You will open a graphical interface menu where you need to choose Performance Options:

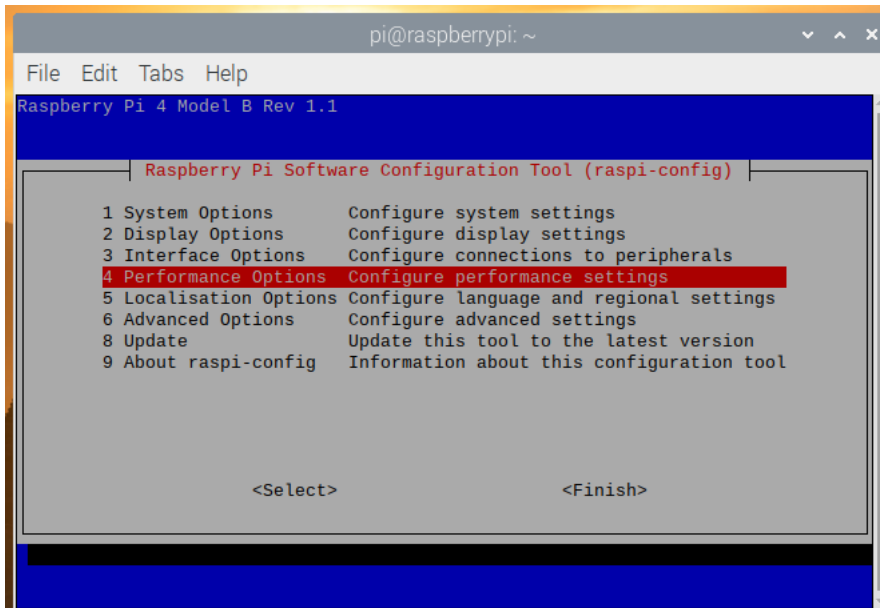

Then Choose “Fan”

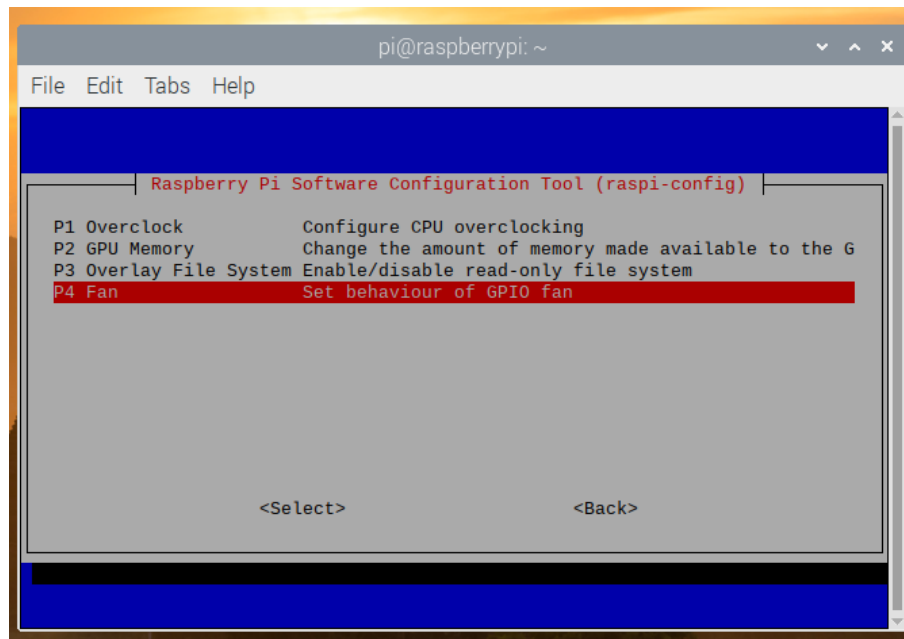

It will ask you if you want to enable fan temperature control? – Choose “Yes”



Here you need to set GPIO 4

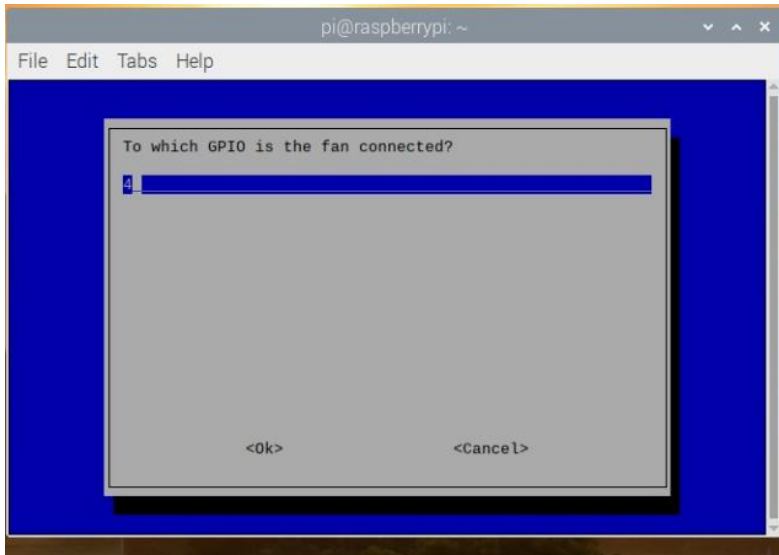

Then set the temperature on which the fan will turn on

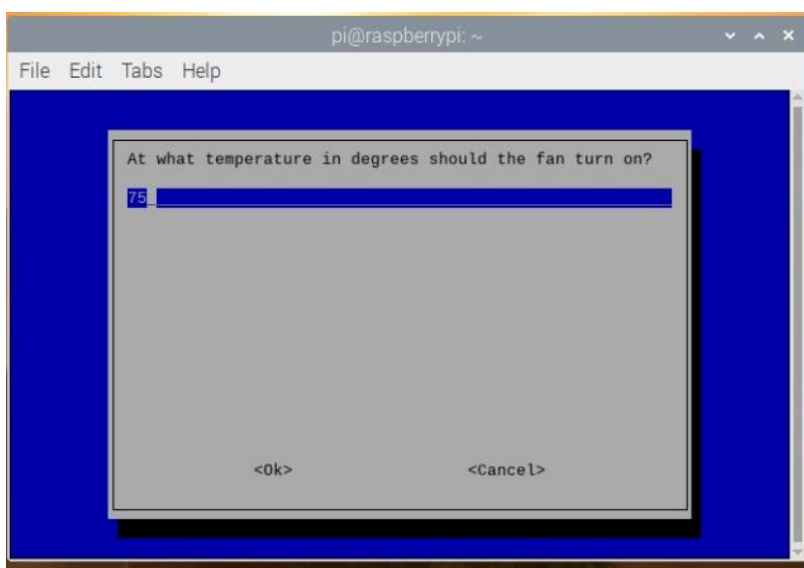

At last the system will inform you about the changes.

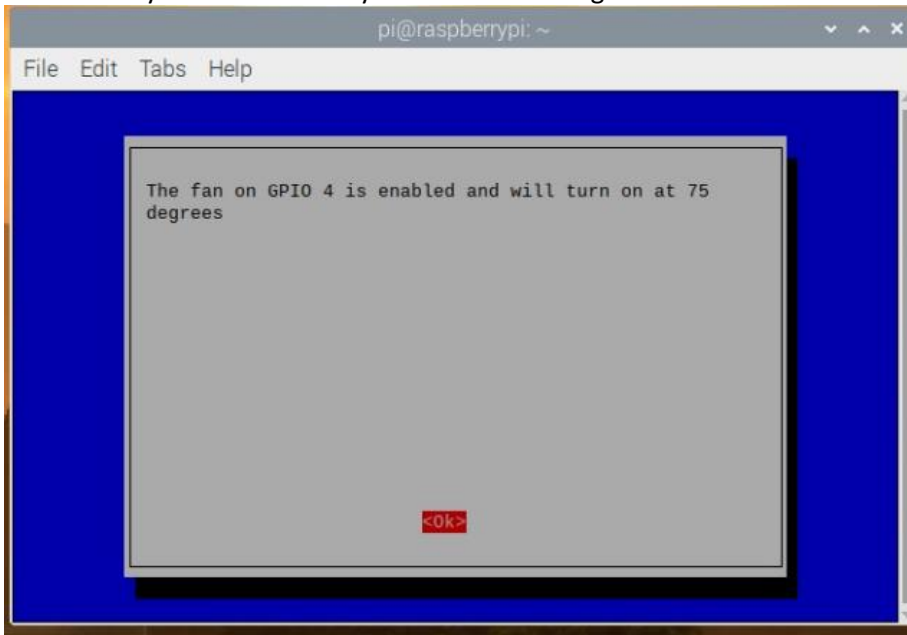

Note: This MaticControl module covers the pins for: 5V power supply, I2C and GPIO14 (TXD). If you want to use them, we offer modules (HATs) that provide access to these pins via separate connector on the top of the board.

Electrical Scheme of the module:

